

PRIMARY AND SECONDARY LEACHATE COLLECTION SYSTEM SUMP PLAN
SCALE: 1" = 6'

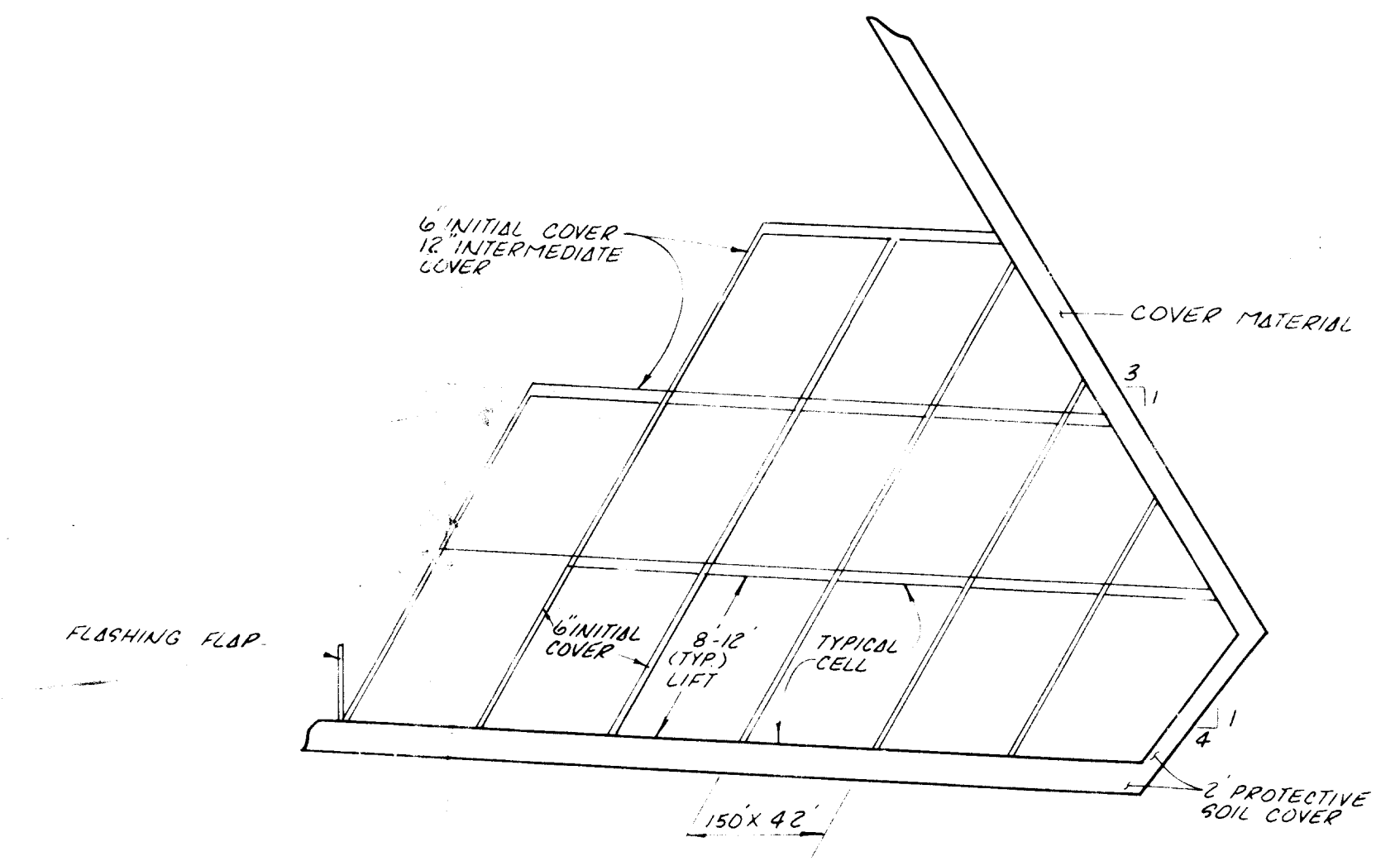

TYPICAL SECTION THRU CELLS
SCALE: 1" = 50' HOR.
1" = 10' VERT.

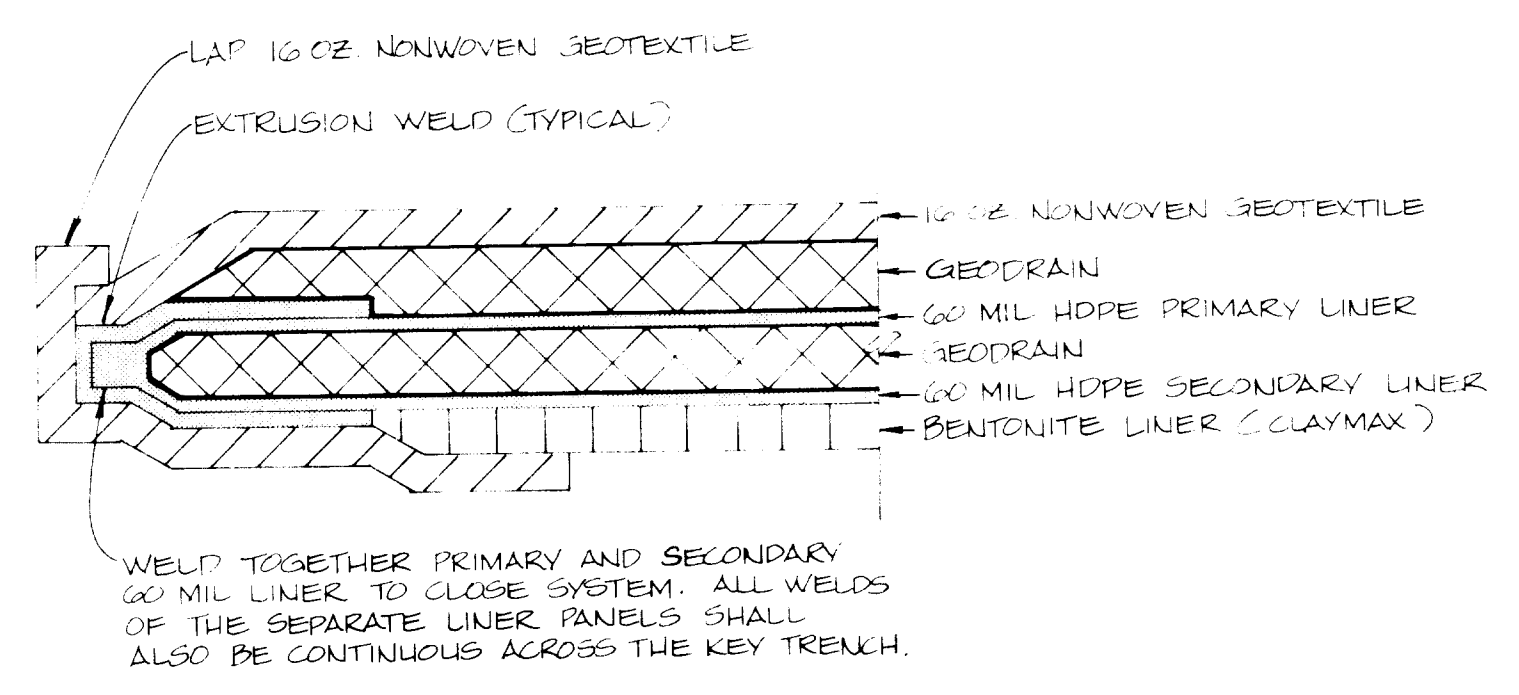

PRIMARY AND SECONDARY LINER END TREATMENT
N.T.S.

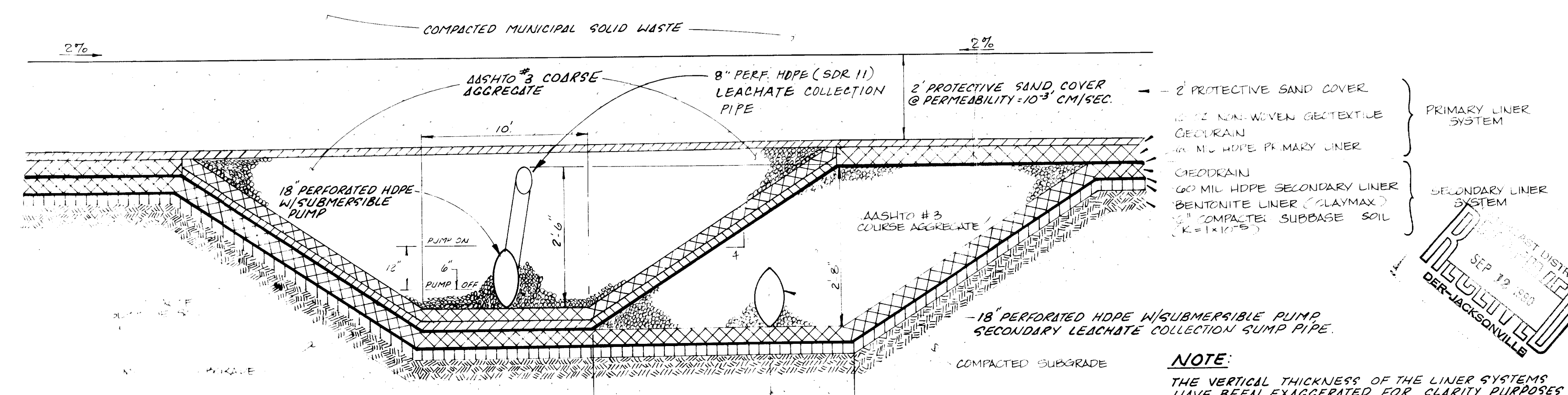

LEACHATE COLLECTION SYSTEM

W.T.C.S. # 3362
C.L.I.
ENGINEERED
DESIGNED
DRAWN
DATE 08/21/89

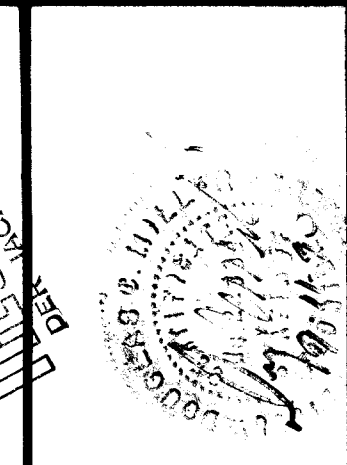

DESIGNED BY	DATE
DRAWN BY	DATE
CHECKED BY	DATE
DATE	JUNE 18, 1990

LEACHATE COLLECTION DETAILS
TRAIL RIDGE LANDFILL
(PLAN A)

England-Thimms & Miller, Inc.
Consulting & Design Engineers
JACKSONVILLE, FLORIDA

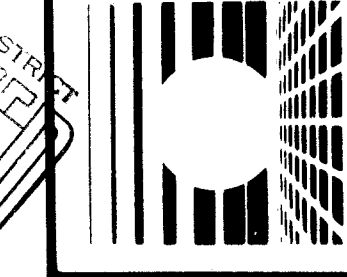

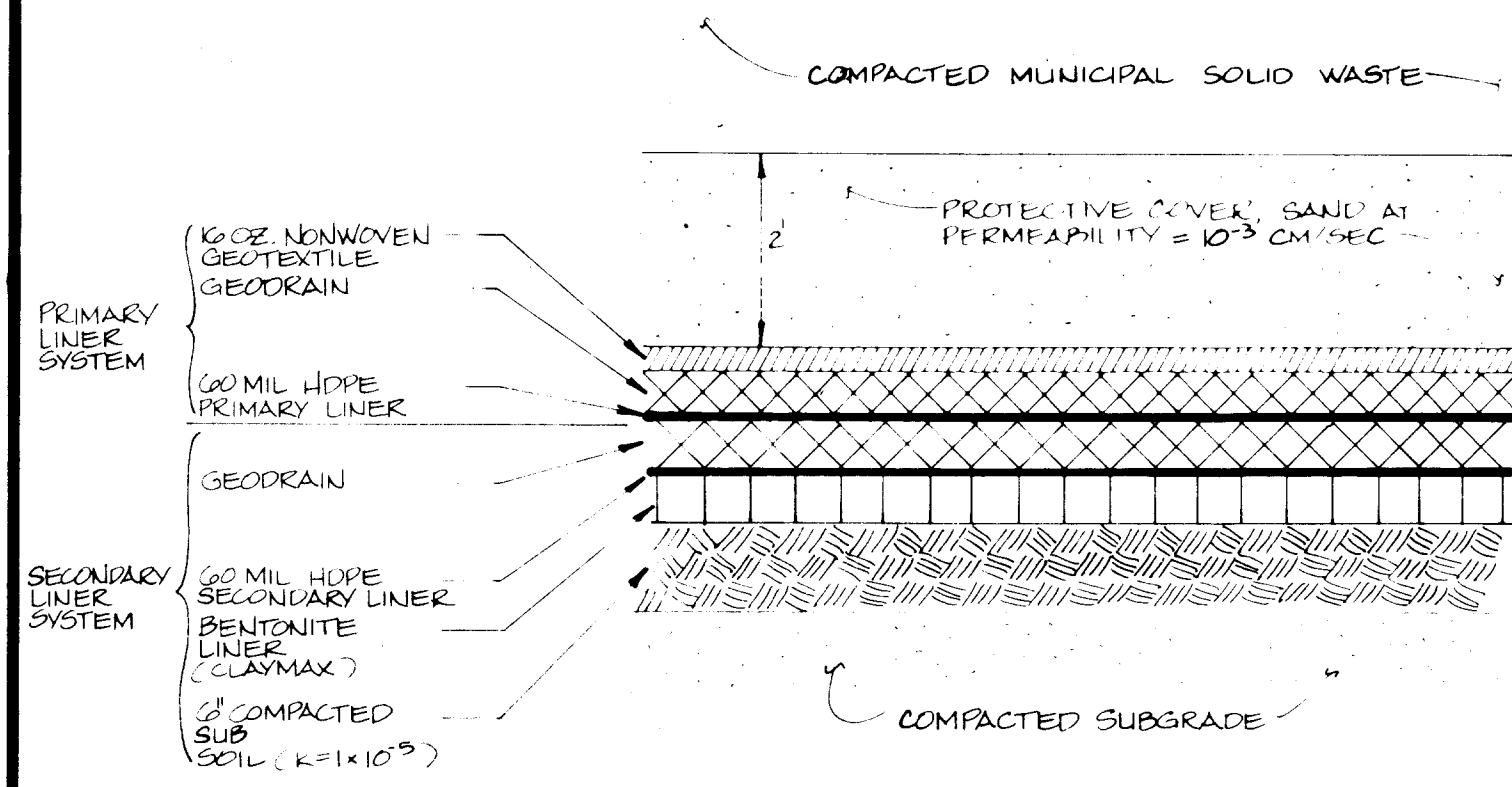

PRIMARY / SECONDARY LINER SYSTEM
N.T.S.

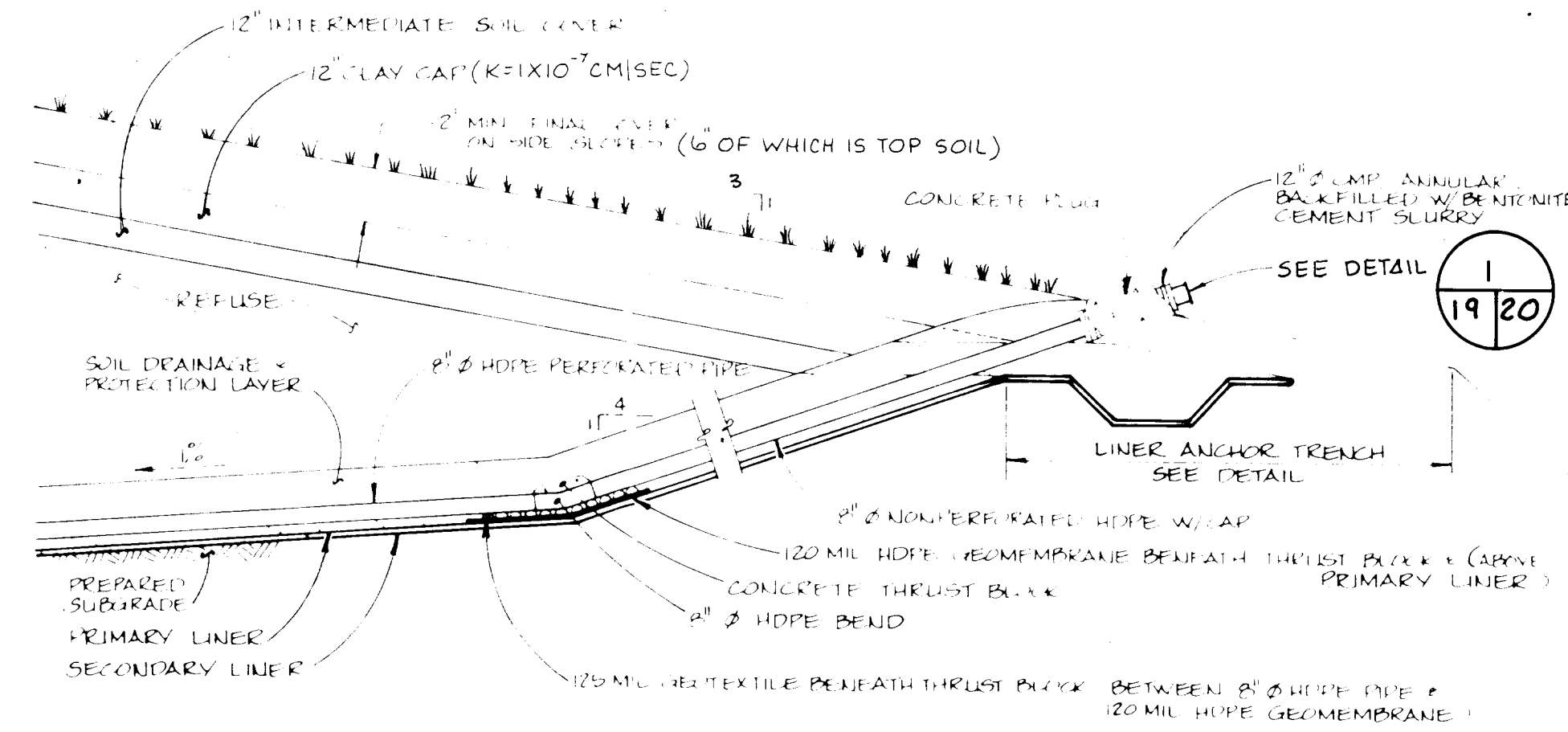

LEACHATE CLEANOUT RISER
N.T.S.

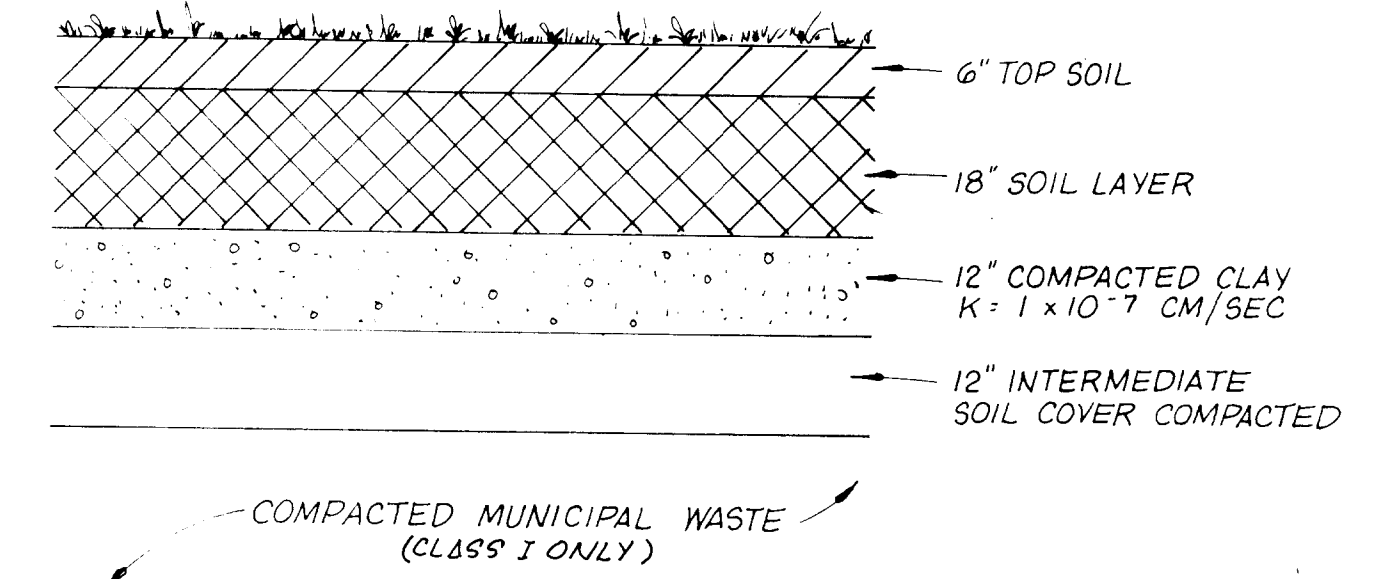

FINAL COVER - CLASS I & III
N.T.S.

LINER MATERIAL SCHEDULE

MATERIAL	MANUFACTURER & PRODUCT
16 oz. NONWOVEN GEOTEXTILE	TREVIRA 1155 OR EQUAL
GEODRAIN	POLYNET PN-3000 OR EQUAL
60 MIL HDPE LINER	NATIONAL SEAL COMPANY, HDPE 60 MIL OR EQUAL
BENTONITE LINER	CLAYMAX

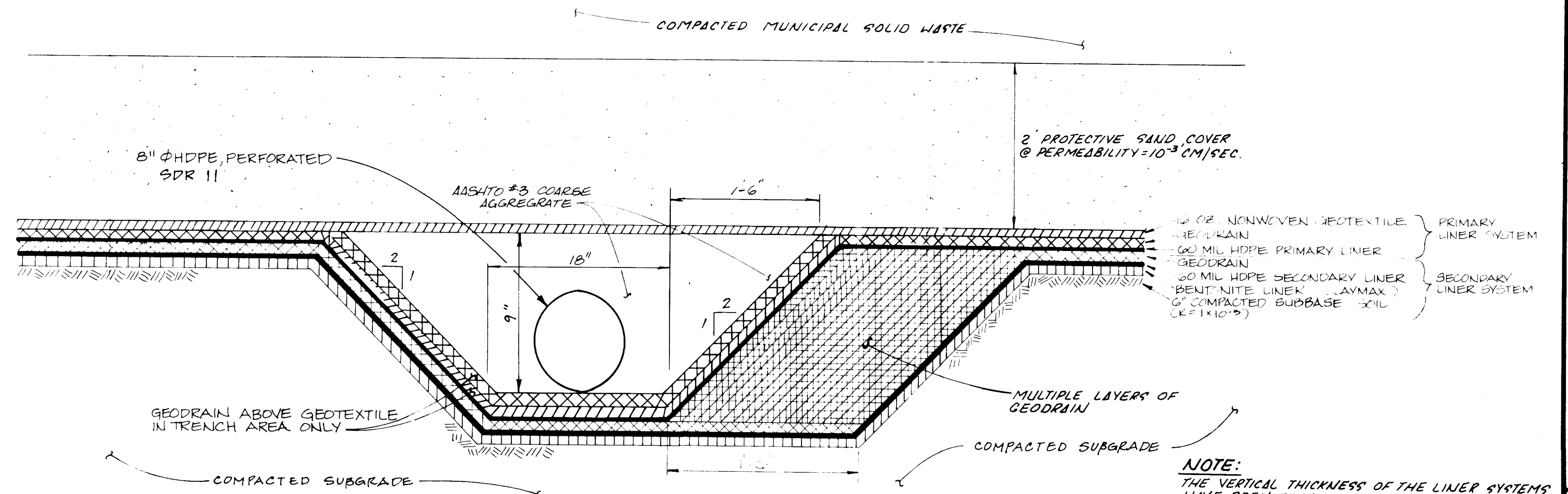

LEACHATE COLLECTION SYSTEM
NTS

NOTE:
THE VERTICAL THICKNESS OF THE LINER SYSTEMS
HAVE BEEN EXAGGERATED FOR CLARITY PURPOSES ONLY.



REVISED CONFIGURATION OF
LINER SYSTEM

DATE: 89-113-9
DRAWN BY: RWH
CHECKED BY: RFF
DATE: JUNE 18, 1990

LINER DETAILS

TRAIL RIDGE LANDFILL
(PLAN A)

England-Thims & Miller, Inc.
Consulting & Design Engineers
JACKSONVILLE, FLORIDA



DRAWING NO.

19

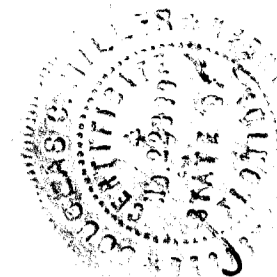

REVISED CONFIGURATION OF
LINER SYSTEM
1-4-91

ENG. PART. NO. E 89-113-9
DRAWN BY C.D.T.
CHECKED BY R.C.F.
DATE JUNE 18, 1990

PHASING DETAILS

TRAIL RIDGE LANDFILL
(PLAN A)

England-Thims & Miller, Inc.

Consulting & Design Engineers
JACKSONVILLE, FLORIDA

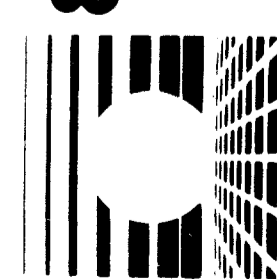

DRAWING NO.

20

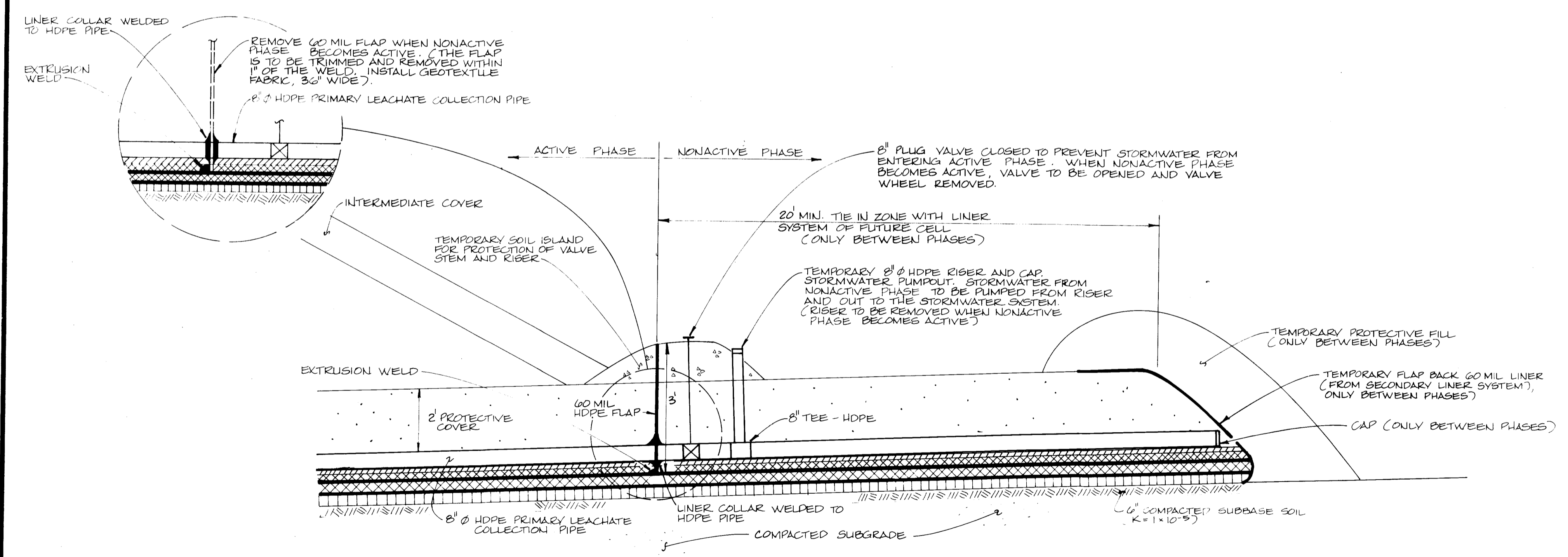
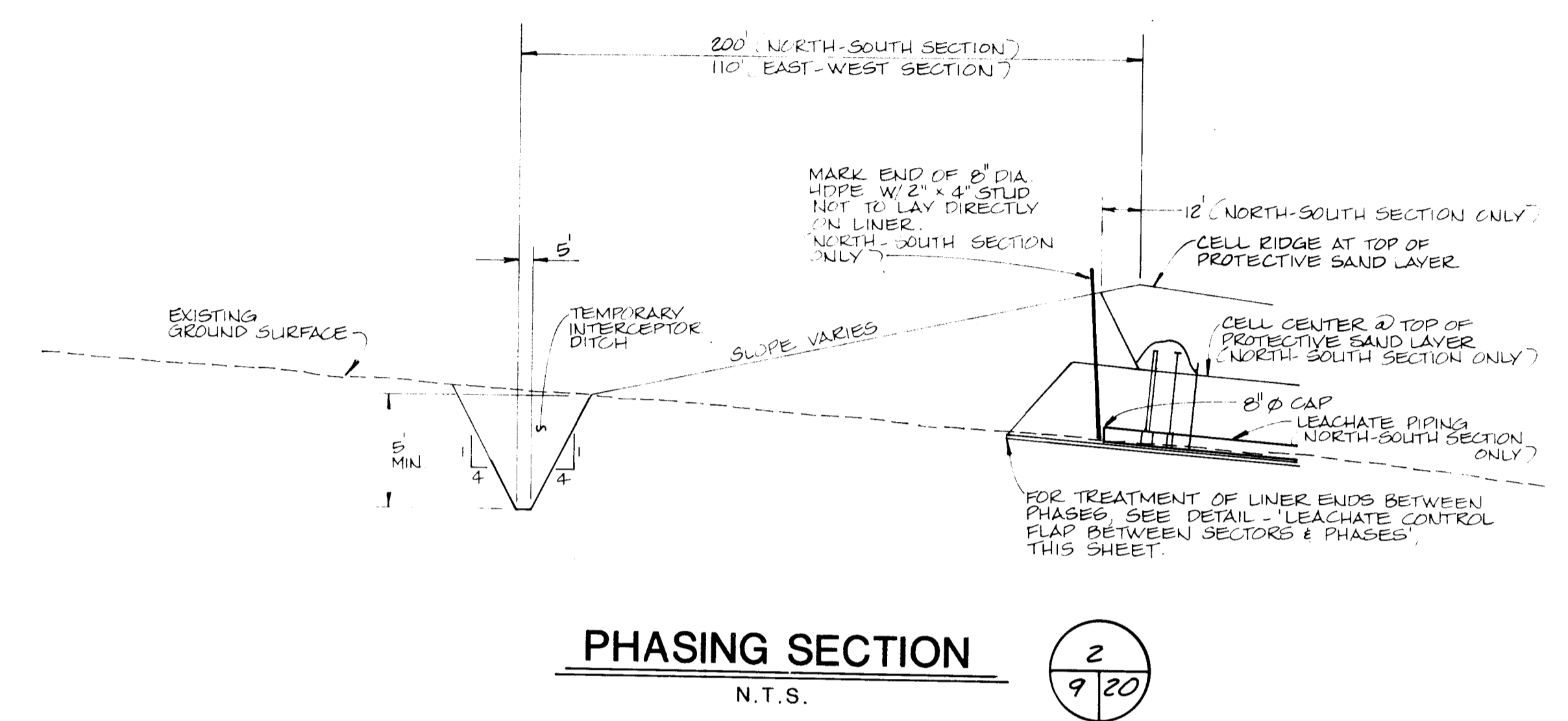

LEACHATE CONTROL FLAP BETWEEN NORTH-SOUTH PHASES
N.T.S.

NOTE: EAST-WEST SECTION IDENTICAL EXCEPT DELETE LEACHATE PIPING

1
9/20

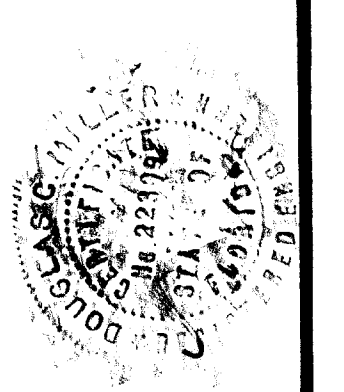
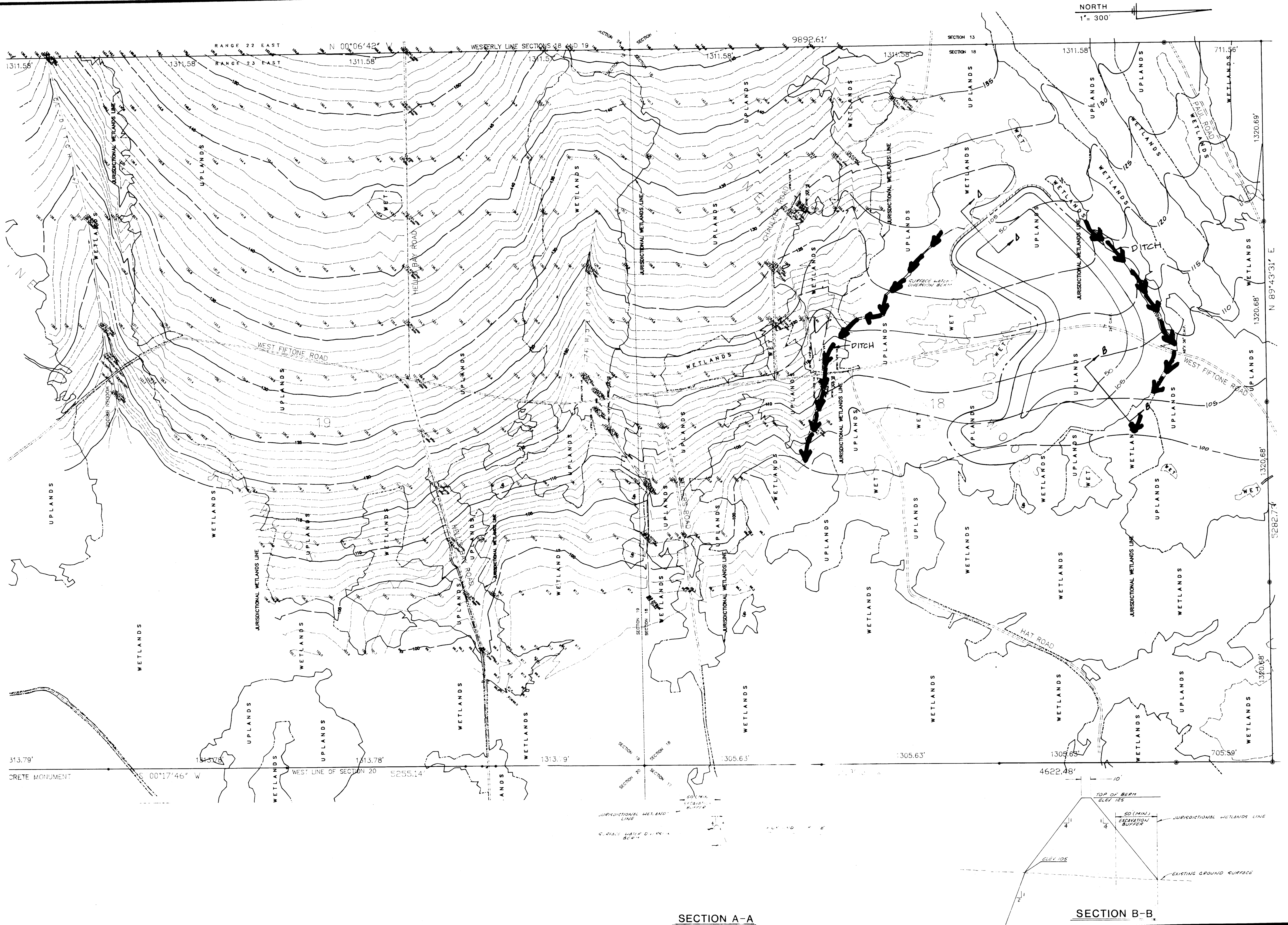

REVISIONS:
 9-11-90 SHOW LOCATION OF DITCHES
 AROUND BORROW PIT

DESIGNED BY:
 EM-113-1
 DRAWN BY:
 TLD
 CHECKED BY:
 JAT
 DATE:
 JULY 23, 1990

NORTH BORROW AREA
TRAIL RIDGE LANDFILL

England-Thimms & Miller, Inc.
 Consulting & Design Engineers
 JACKSONVILLE, FLORIDA

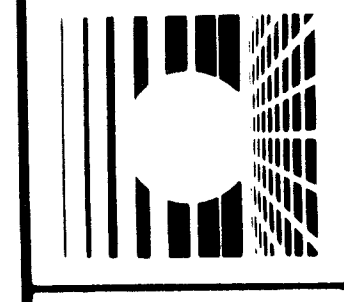

DRAWING NO
24A

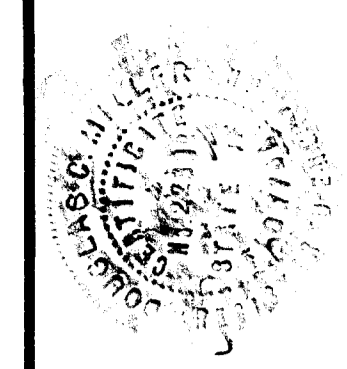
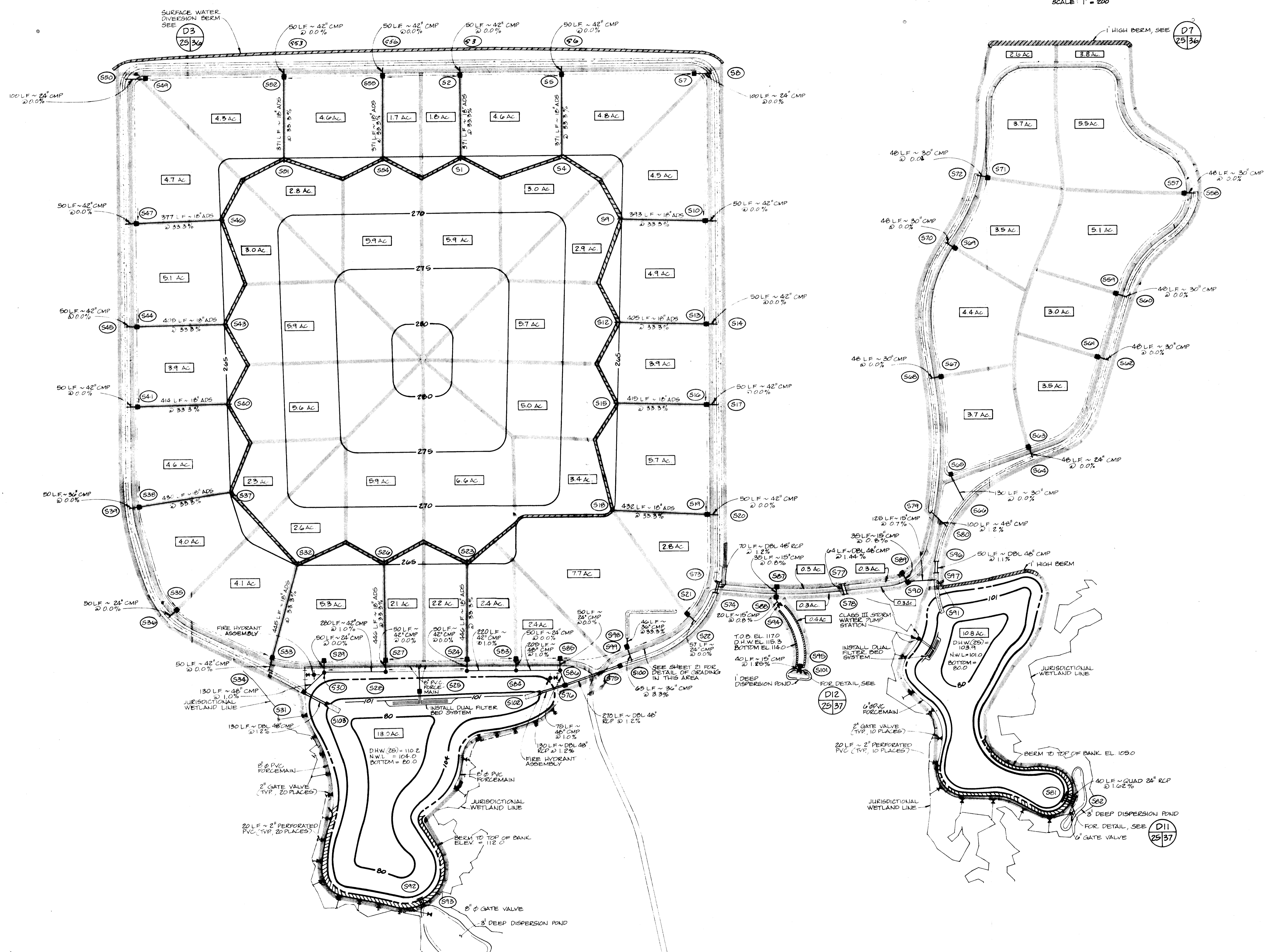

PROJ. NO.	88-4138
DRAWN BY:	TLO
CHECKED BY:	SMA
DATE	JUNE 18, 1990

STORMWATER MANAGEMENT PLAN

TRAIL RIDGE LANDFILL (PLAN A)

England-Thims & Miller, Inc.
Consulting & Design Engineers
JACKSONVILLE, FLORIDA

DRAWING NO.
25

